

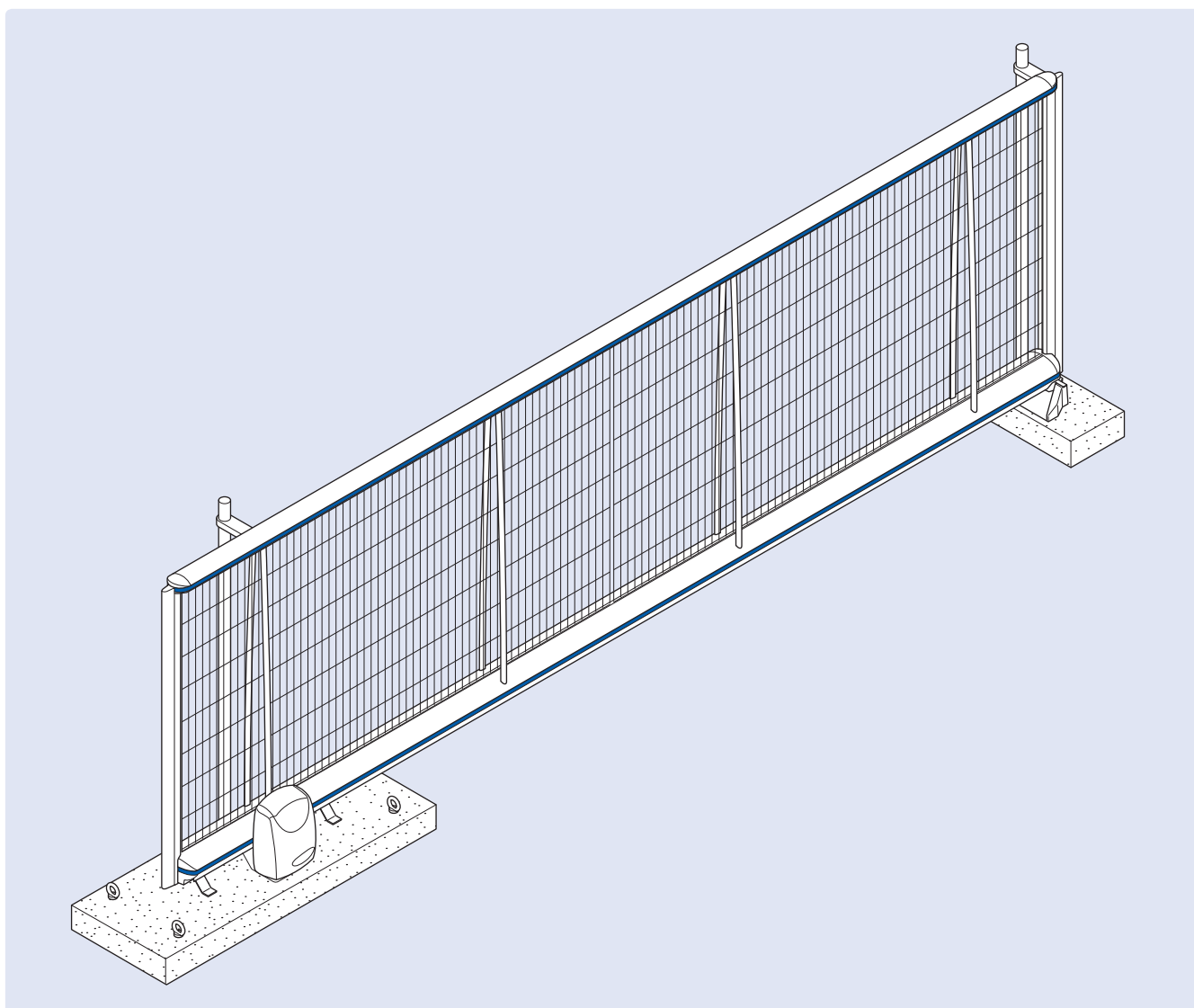

Installatie handleiding  
Installation manual  
Manuel d'installation  
Installations-Handbuch

# Argos /prefab

Nederlands	2
English	4
Deutsch	6
Français	8





## Disclaimer

Neem deze handleiding vòòr installatie volledig door. Alle beschreven werkzaamheden moeten worden uitgevoerd door gecertificeerd personeel. Als er afgeweken wordt van de beschreven handelingen vervalt elke vorm van garantie en aansprakelijkheid van de fabrikant.

## Veiligheid

Draag altijd de juiste beschermde kleding bij het uitvoeren van de werkzaamheden.

Gebruik altijd een tilhulp/hijsinstallatie bij het verplaatsen van zware en/of grote objecten.

Gebruik altijd passend gereedschap.

Het toevoegen of weglaten van onderdelen, anders dan beschreven in deze handleiding, kan nadelige gevolgen hebben op het functioneren en dus de veilige werking van het uiteindelijke product en wordt dan ook ten strengste afgeraden.



**GEVAAR!** Laat werkzaamheden aan elektrische onderdelen door gecertificeerd personeel uitvoeren.

## Verwijdering en demontage

Voer het product af volgens de lokale wet- en regelgeving.

Voor gebruik en onderhoud zie de gebruikershandleiding en/of servicehandleiding.

## Maatvoering

Alle maten en afmetingen zijn in mm tenzij anders vermeld.

## Contact

Zie achterzijde van deze handleiding.



## Uitleg symbolen

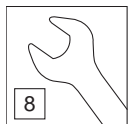

Gebruik een steeksleutel  
Het cijfer geeft de steekmaat in mm aan.

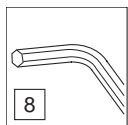

Gebruik een inbussleutel  
Het cijfer geeft de steekmaat in mm aan.

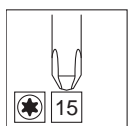

Gebruik een schroevendraaier  
Het symbool geeft het type schroef aan. Het cijfer geeft de afmeting van de schroef aan.

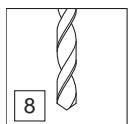

Gebruik een boor  
Het cijfer geeft de boordiameter in mm aan.

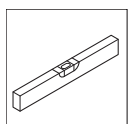

Zorg ervoor dat de aangegeven niveaus waterpas zijn.

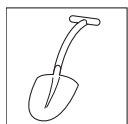

Graaf een gat

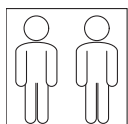

Voer de werkzaamheden niet alleen uit

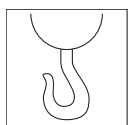

Gebruik een tilhulp/hijsinstallatie

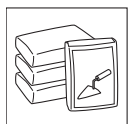

Gebruik beton  
Volg de instructies op de verpakking.

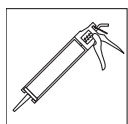

Gebruik injectie mortel  
Volg de instructies op de verpakking.



Werklijn poort  
Geeft de werklijn van de poort aan.

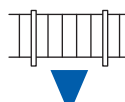

Hekwerklijn  
Geeft de hekwerklijn van een (bestaand) hekwerk aan.



Kijkhoek  
Er wordt een afwijkende kijkhoek gebruikt.



Pagina referentie  
Geeft een verwijzing naar een pagina aan.



Tekening referentie  
Geeft een verwijzing naar een tekeningnummer aan.



## Disclaimer

Read the full manual before installation. All described work must be performed by certified personnel. Should you deviate from the described actions, any guarantee entitlement and liability of the manufacturer shall no longer apply.

## Safety

Always wear the correct protective clothing when performing the work.

Always use a lifting tool/hoisting system when moving heavy and/or large objects.

Always use suitable tools.

Adding or removing parts other than as described in this manual can have negative consequences on the operation and, therefore, the safe operation of the final product and we categorically advise against this.



**DANGER!** Have work on electric parts only performed by certified personnel.

## Removing and disassembling

Dispose of the product in accordance with local legislation and regulations.

For use and maintenance see the user manual and/or service manual.

## Dimensioning

All sizes and dimensions are in mm unless stated otherwise.

## Contact

See the reverse of this manual.



## Explanation of used symbols

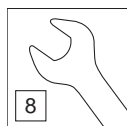

Use an open-end spanner  
The number specifies the insertion size in mm.

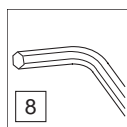

Use an Allen key  
The number specifies the insertion size in mm.

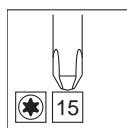

Use a screwdriver  
The symbol specifies the type of screw. The number specifies the size of the screw.

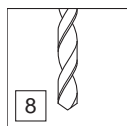

Use a drill  
The number specifies the drill bit diameter in mm.

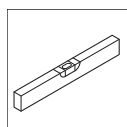

Ensure that the specified levels are level.

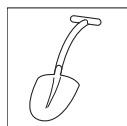

Dig a hole

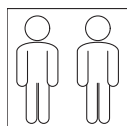

Do not perform the work on your own.

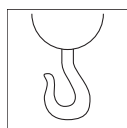

Use a lifting tool/hoisting system.

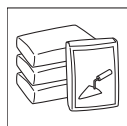

Use concrete  
Follow the instructions on the packaging.

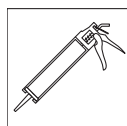

Use grout  
Follow the instructions on the packaging.



Line of action of the gate  
Specifies the line of action of the gate.

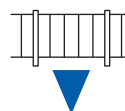

Fencing line  
Specifies the fencing line of an (existing) fence.



Viewing angle  
A different viewing angle is used.



Page reference  
Specifies a reference to a page.



Drawing reference  
Specifies a reference to a drawing number.



## Haftungsausschluss

Lesen Sie vor der Installation die gesamte Anleitung. Alle beschriebenen Arbeiten müssen durch zertifiziertes Personal ausgeführt werden. Bei Abweichungen von den beschriebenen Handlungen erlischt jegliche Garantie oder Haftung des Herstellers.

## Sicherheit

Tragen Sie bei der Ausführung der Arbeiten immer angemessene Schutzkleidung.

Verwenden Sie zum Bewegen von schweren und/oder großen Gegenständen immer entsprechendes Hebezeug.

Verwenden Sie immer angemessenes Werkzeug.

Das Hinzufügen oder Entfernen von Teilen, abgesehen von den in dieser Anleitung beschriebenen Fällen, kann sich nachteilig auf die Funktion und damit auf den sicheren Betrieb des Endprodukts auswirken. Daher wird dringend davon abgeraten.



GEFAHR! Lassen Sie Arbeiten an elektrischen Teilen durch zertifiziertes Personal durchführen.

## Ausbau und Demontage

Entsorgen Sie das Produkt gemäß örtlichen Gesetzen und Richtlinien.

Zu Bedienung und Wartung siehe Bedienungs- und/oder Wartungsanleitung.

## Aufmaß

Alle Maße und Abmessungen in mm, sofern nicht anders angegeben.

## Kontakt

Siehe Rückseite dieser Anleitung.



## Symbolverzeichnis

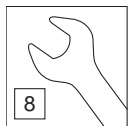

Gabelschlüssel verwenden  
Die Ziffer gibt die Schlüsselgröße  
in mm an.

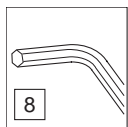

Inbusschlüssel verwenden  
Die Ziffer gibt die Schlüsselgröße  
in mm an.

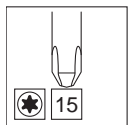

Schraubendreher verwenden  
Das Symbol gibt die Art der  
Schraube an. Die Ziffer gibt die  
Abmessung der Schraube an.

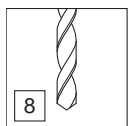

Bohrer verwenden  
Die Ziffer gibt den  
Bohrerdurchmesser in mm an.

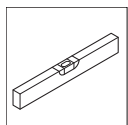

Sorgen Sie dafür, dass  
die angegebenen Niveaus  
waagrecht sind.

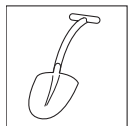

Ein Loch graben

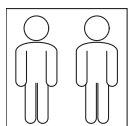

Die Arbeiten nicht allein  
ausführen

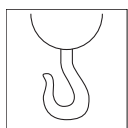

Ein Hebezeug verwenden

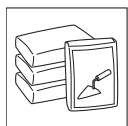

Beton verwenden  
Befolgen Sie die Anweisungen  
auf der Verpackung.

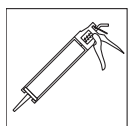

Einpressmörtel verwenden  
Befolgen Sie die Anweisungen  
auf der Verpackung.



Torlinie  
Gibt den Verlauf des Tors an.

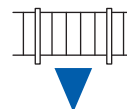

Zaunlinie  
Gibt den Verlauf eines  
(bestehenden) Zauns an.



Blickwinkel  
Es wird ein abweichender  
Blickwinkel verwendet.



Seitenreferenz  
Gibt einen Verweis auf eine  
Seite an.



Zeichnungsverweis  
Gibt einen Verweis auf eine  
Zeichnungsnummer an.



## Déni de responsabilité

Lire entièrement ce manuel avant de procéder à l'installation. Tous les travaux décrits doivent être effectués par un personnel certifié. Tout écart par rapport aux instructions décrites entraînera l'annulation de toute forme de garantie et de responsabilité du fabricant.

## Sécurité

Porter toujours les vêtements de protection appropriés lors de l'exécution des travaux.

Utiliser toujours un accessoire de levage/ appareil de relevage pour déplacer des objets lourds et/ou volumineux.

Utiliser toujours un outillage adéquat.

L'addition ou la suppression de pièces autres que celles décrites dans ce manuel peuvent avoir des effets négatifs sur le fonctionnement et donc sur la sécurité de fonctionnement du produit fini. Elles sont donc vivement déconseillées.



**DANGER !** Confier les travaux visant les composants électriques à un personnel certifié..

## Enlèvement et démontage

Évacuer le produit conformément aux dispositions légales et réglementaires locales.

Pour l'utilisation et l'entretien, voir le manuel d'utilisation et/ou le manuel de maintenance.

## Cotes et dimensions

Sauf indication contraire, toutes les cotes et dimensions sont exprimées en mm.

## Contact

Voir au dos de ce manuel.





## Signification des symboles



Utiliser une clé plate  
Le chiffre indique le calibre en mm.

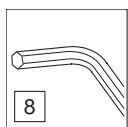

Utiliser une clé Allen  
Le chiffre indique le calibre en mm.

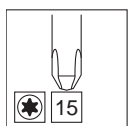

Utiliser un tournevis  
Le symbole indique le type de vis. Le chiffre indique la dimension de la vis.

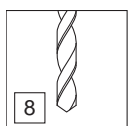

Utiliser une perceuse  
Le chiffre indique le diamètre de perçage en mm.

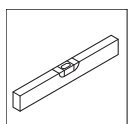

Veiller à ce que les niveaux indiqués soient de niveau.

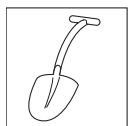

Creuser un trou

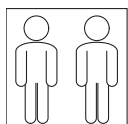

Ne pas exécuter les travaux seul

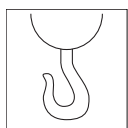

Utiliser un accessoire de levage/  
appareil de relevage

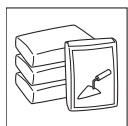

Utiliser du béton  
Suivre les instructions mentionnées sur l'emballage.

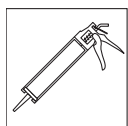

Utiliser du coulis  
Suivre les instructions mentionnées sur l'emballage.



Ligne d'action du portail  
Indiquer la ligne d'action du portail.

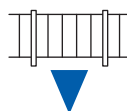

Ligne d'action de la clôture  
Indiquer la ligne d'action d'une clôture (existante).



Angle d'observation  
Un angle d'observation différent est utilisé.



Référence de page  
Indique un renvoi à une page.



Référence de dessin  
Indique un renvoi à un numéro de dessin.

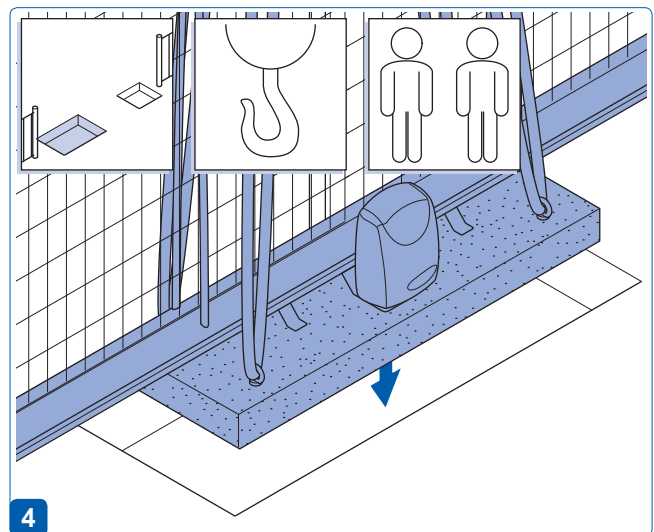
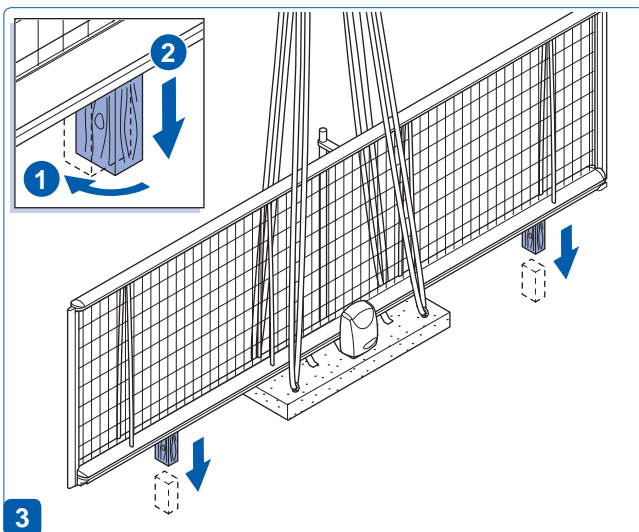
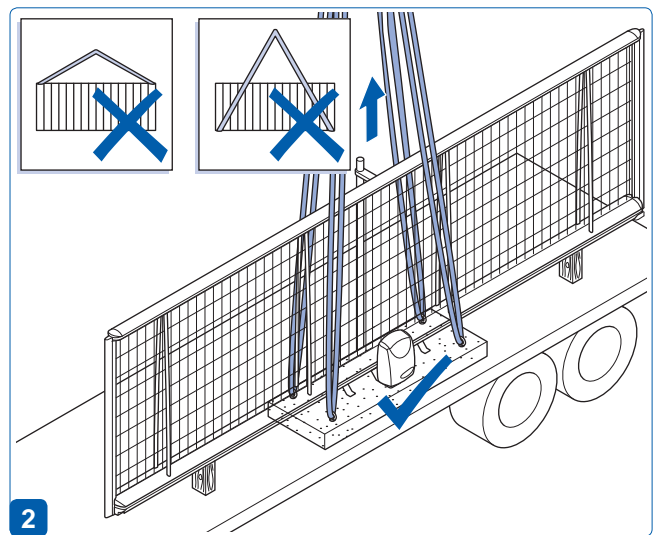
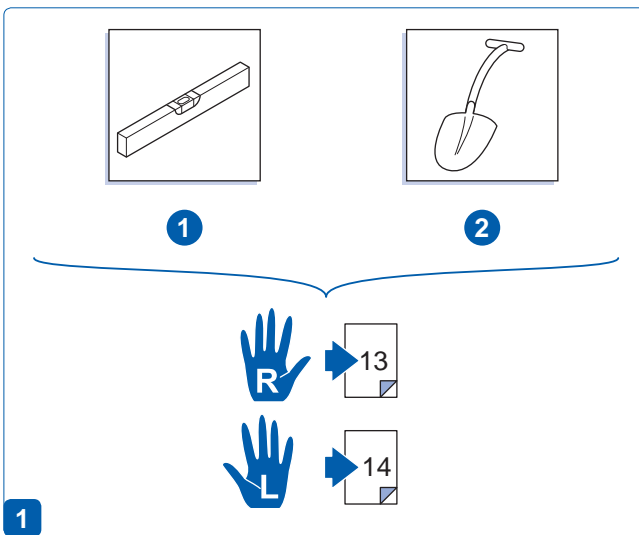
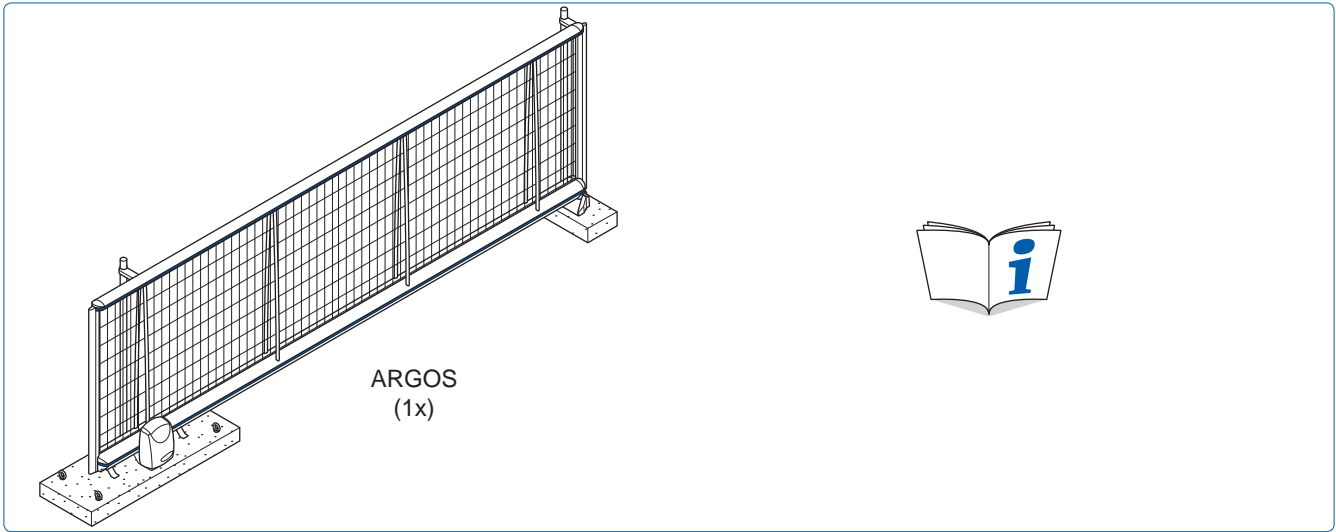

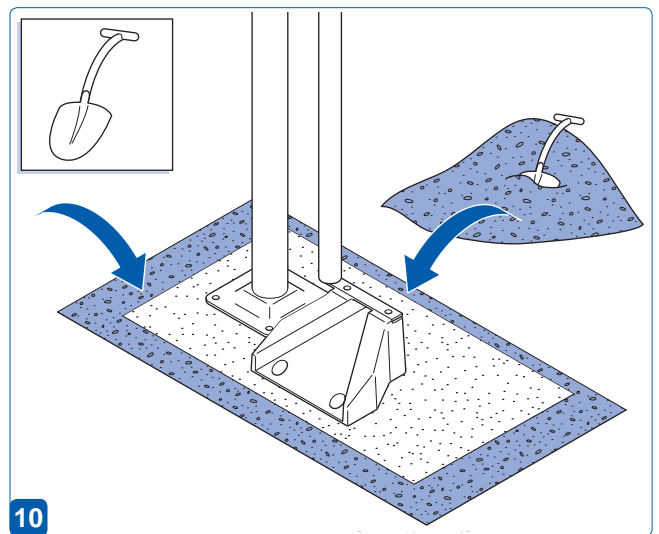
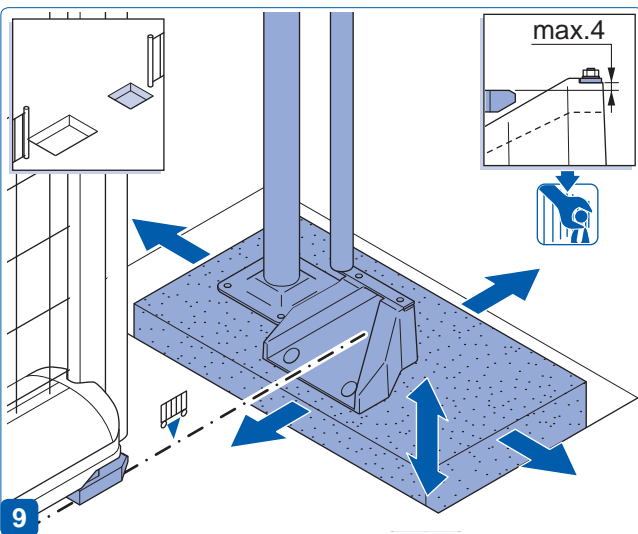
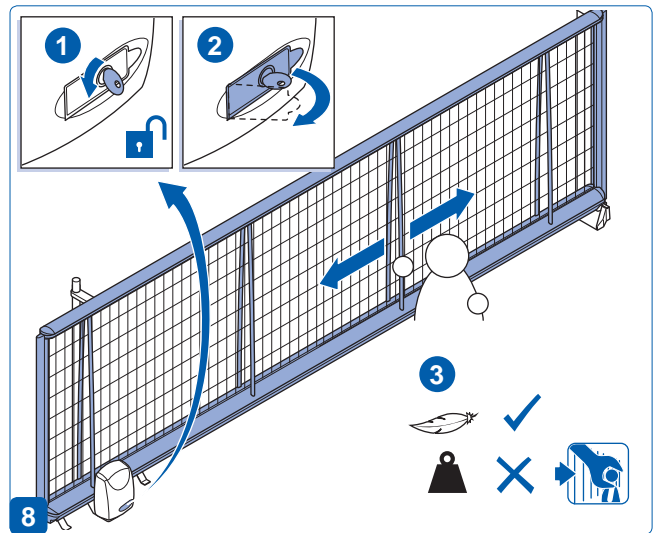
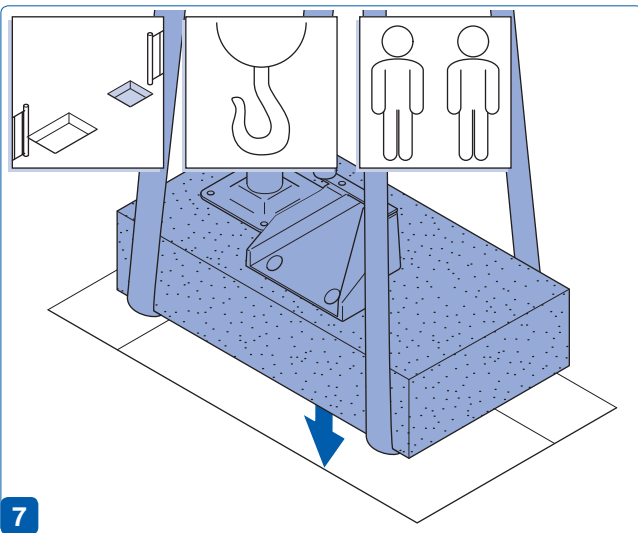
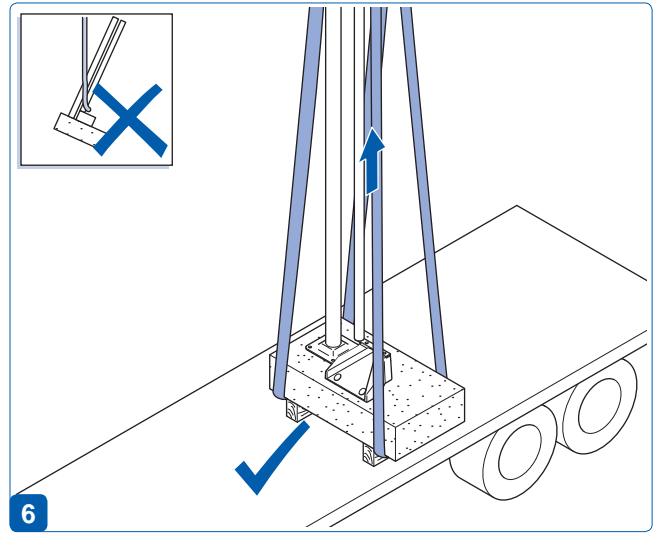
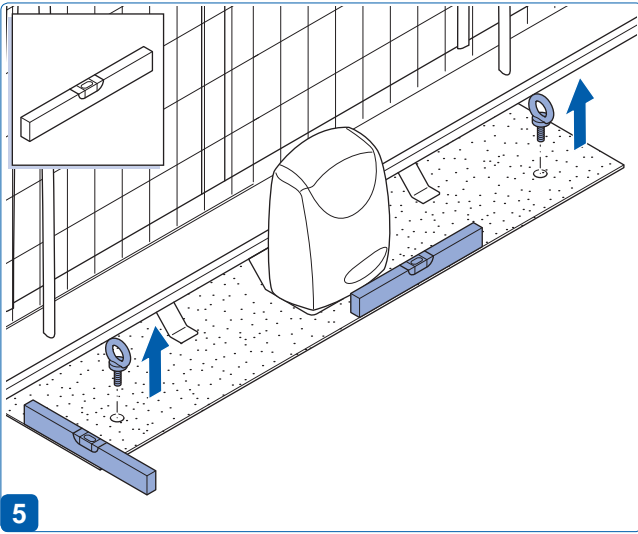

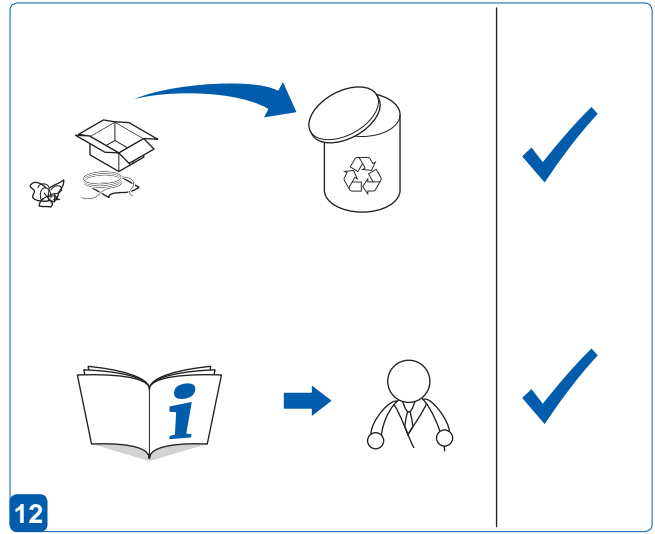
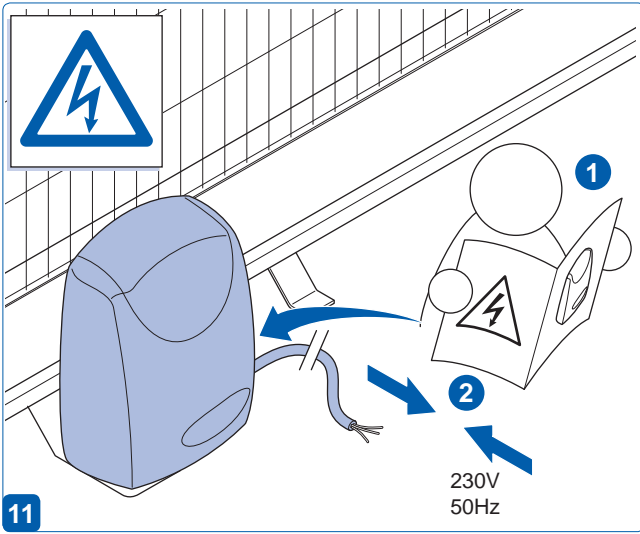

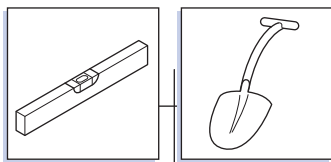
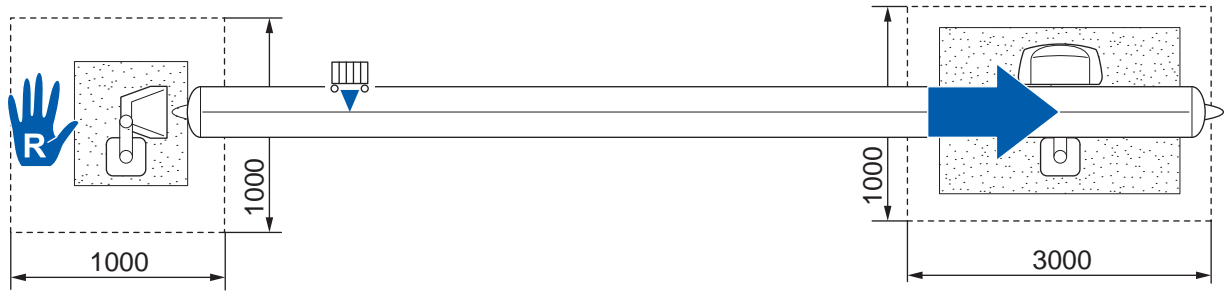

▣	A
5m	3685
6m	4841
7m	6640

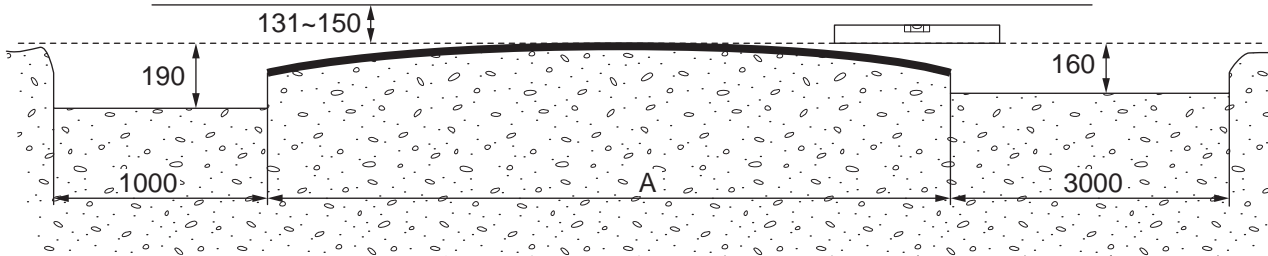

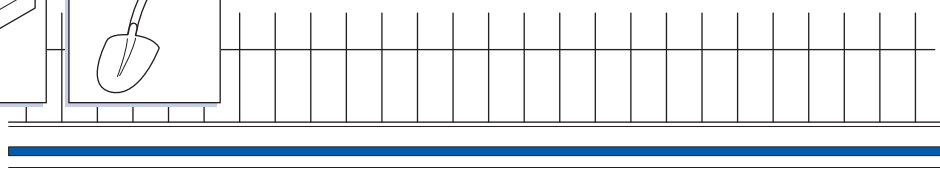
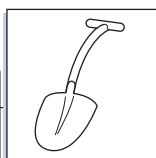
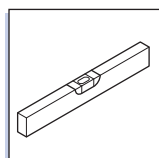

Icon	A
5m	3685
6m	4841
7m	6640

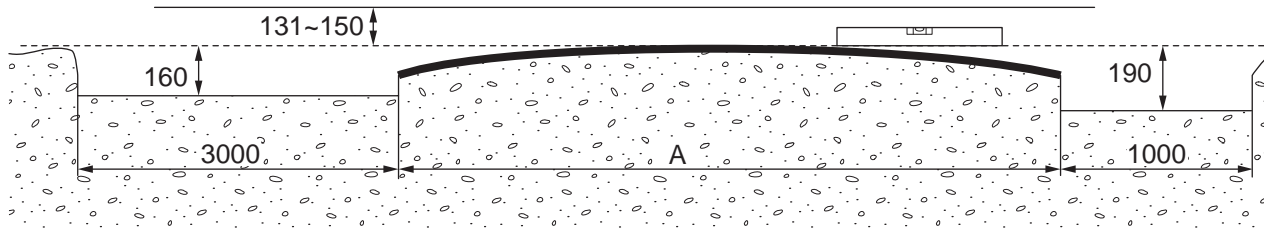





---

**Heras Fencing Systems BV**  
**Hekdam 1 (uu)**  
**Postbus 30**  
**NL-5688ZG Oirschot**

**Tel: +31 499 55 15 23**  
**Fax: +31 499 55 15 70**  
**E-mail: [sales@heras.com](mailto:sales@heras.com)**

---

Local supplier stamp/